

Luxaflex®

Fabric Awnings and
External Sunscreens





External Sunscreens

Folding Arm Awnings



Monaco Cassette Awning - closed

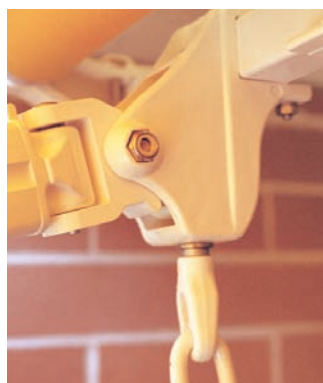

Bedarra Awning showing variable pitch adjustment



Arms are fitted with stainless steel chains

Luxaflex®

Fabric Awnings and
External Sunscreens





System 2000 Pivot Arm and Straight Drop Awnings

The most effective way of preventing solar heat gain through windows is to stop the heat before it reaches the glass by providing exterior shading. The LUXAFLEX® Fabric Awning range is extensive and versatile.

Models

- External Sunscreens
- Folding Arm Awnings
- Robusta Awnings
- Rollamatic Awnings
- System 2000 Awnings
- Shop-front Awnings
- Canopy Awnings

Colour Range

Fabric Awnings – over 70 colours in canvas and acrylic fabric

External Sunscreens – 8 colours

Applications

- Any building that requires shading
- Retail stores, restaurants, cafes – awnings can add colour to the exterior or interior of the building and can be sign-written for visual impact
- Folding Arm Awnings provide shade for outdoor living and eating areas

Fabric Specification Overview

Canvas fabric 52% polyester 48% cotton mix. Treated with anti-mould and mildew agents and TEFLON® Fabric Protector.

Solaire Acrylic fabric is 100% acrylic fibre treated to prevent growth of mould and mildew.

ScreenShade fabric is PVC coated polyester.

Hardware Specification Overview

Fabric Awnings & External Sunscreens

Exposed aluminium and steel components coated to AS3715 (powder coated parts) or AS2728 (painted parts), both to Type 3 (mild to moderate, tropical and industrial, exterior) for corrosion protection. All plastic components are UV stabilised.

Durability

Colour fastness of fabric: 6-7 Blue Scale (where the maximum score is 7) (AS 2001.4.21)

The arms of Folding Arm Awnings meet Tuv Standard for design. System 2000 Awnings have been wind load tested by the CSIRO*.

* CSIRO Report No. DTA233

Energy Benefits

Preventing heat from entering a building through the window can make a significant difference to cooling costs over the life of the building.

Roll-up fabric awnings can reflect 70% of heat (or more for lighter colours) before it reaches the window and have the added benefit of being retracted during winter to allow winter sun to enter the building to reduce heating costs.

External sunscreens can reduce internal temperatures by 5-15°C compared with an unshaded window.

Many awnings can be automated using sun and wind sensors, or connected to building management systems to optimise energy savings. In fact, careful selection of shading integrated in building design can avert the need for air-conditioning altogether.

Environmental and Employee Benefits

Awnings can be selected to give building occupants the optimum combination of light and heat control, privacy and view to the outside.

Many are user adjustable, giving people control of their environment. Reduction of inside temperatures in summer significantly improves interior comfort levels.

Hunter Douglas Limited, the manufacturer of LUXAFLEX Window Coverings, operates under an Environmental Management System that actively works towards waste and emission reduction and maximising the use of recycling.

Australian Made

The System 2000 Awning was designed in Australia and won an Australian Design Award. The EOS® External Sunscreen was also designed in Australia.

Canvas is woven and coated in Australia by Hunter Douglas Limited.

LUXAFLEX® Awnings are made to measure in Australia.

Quality

Hunter Douglas Limited, the supplier of the LUXAFLEX Awning components, is a quality endorsed company, certified as complying with the requirements of AS/NZS ISO 9001:2000.

Commercial Warranty

All LUXAFLEX Awnings are covered by a two year Commercial Warranty. Conditions apply.

Reference Projects

The Emporium/Brisbane/Anthony John Group

South Bank House Project/Brisbane/

South Bank Corporation - Asset Management

Domo Collections/Adelaide

System 2000 Motorised Awnings



Models and Options

System 2000 Awning

System 2000 Awnings are a revolutionary awning that can be fitted to almost any window fixture. The adjustable anchoring brackets can be located onto the nearest structural support which positions the awning directly over the window, optimising the skin overhang for better sun control. System 2000 Awnings can be installed over windows that are either elevated or at ground level and can be operated by a number of different methods. System 2000 Awnings are suitable for a very wide range of Commercial and Residential applications. Examples include cafes, motels, resorts, retirement homes, hospitals, etc. The System 2000 Awning won an Australian Design Award for its innovative features and has been wind load tested by the CSIRO*.

Features:

- Colour co-ordinated components.
- Available in 3 styles: 'Automatic', allowing close to window shading, 'Pivot Arm', offering projected arm shading, or 'Straight Drop', allowing the fabric to hang vertically.
- The Pivot Arm style offers a choice of 5 operating systems; external rope control, interior motorisation, interior or exterior crank and tape control, or internal tape winch control.
- Available with sun and wind sensors and timers for automated motorised operation of your awning.
- Available with an aluminium skin (except motorised operation and straight drop styles).



AUSTRALIAN DESIGN AWARD

'System 2000' Awning

Licence No. 93230

Automatic

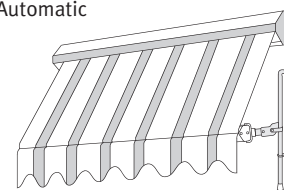

Pivot Arm

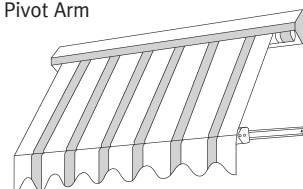

Straight Drop



Folding Arm Awning

A LUXAFLEX® Folding Arm Awning is a retractable awning which provides an extension to living and commercial areas by providing shade that is particularly suitable for patios, terraces, street fronts and floor to ceiling windows.

Features:

- No obtrusive vertical supports.
- Able to project to 3.6 m and up to 15 m wide for Ibiza, 18 m for Bedarra, Standard & Semi-Cassette & 14 m for Monaco.
- Fixed or adjustable pitch options allow you to choose the shading angle required.
- Awnings can be motorised, with optional sun and wind sensors for effortless control.
- Monaco Cassette Awning provides complete protection to fabric and hardware from harsh Australian environmental conditions when retracted.

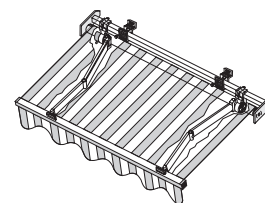

Canopy Awning

For a European look a LUXAFLEX® Canopy Awning is available in nearly an infinite number of shapes, making it a truly custom made product. Available in either fixed or retractable.

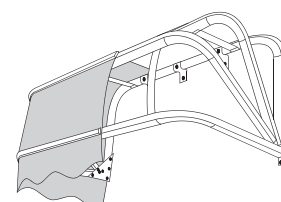

Shop Front Awnings

Shop Front Awnings have become a traditional part of the Australian retail landscape. Vertically oriented awnings are attached to the front of permanent shop awnings, allowing protection for shops and their patrons from summer heat. These awnings are particularly suitable for sign writing and become an integral part of the image of a store.

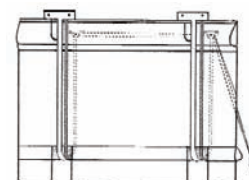

Robusta Awnings

Robusta Awnings are heavy duty fabric awnings suitable for windows large in size or located in windy positions. The features of Robusta Awnings allow them to be used on numerous Commercial or Residential buildings such as schools, hospitals, bungalows, etc.

Features:

- Can be controlled internally by an electric motor or crank-driven for both internal or external operation.
- Can be installed directly to the wall or under building eaves.
- For a care-free operation, can be fitted with an automatic sun, rain and wind sensor.



Rollamatic Awning

Specifically designed for balcony applications, but just as practical as a window awning, the Rollamatic is a spring operated, guided awning. The user simply utilises a hook to pull the bottom rail down to the desired location, where the end caps lock against a stop wedge. To release, simply disengage from the stop wedge and the spring automatically retracts the awning. With no dangling ropes, and corrosion resistant guide rails, the Rollamatic is a neat and strong solution for shading balconies. Available with or without a headbox.

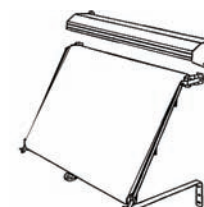

EOS® External Sunscreen

The new EOS® External Sunscreen is a triumph in Australian Design. Able to accommodate window spans up to 4m x 4m in a single skin, the EOS External Sunscreen is by far the largest available.

Although large, the curved lines give the EOS External Sunscreen a sleek appearance, which can be further enhanced by powder coating to match the building exterior.

Features:

- All channels, headbox and rails made from extruded aluminium for corrosion resistance and can be powdercoated to your choice of colour (A).
- Easy to operate, in a choice of winch, gear or motorised operation.
- Optional aluminium side guides (B) or stainless steel cable guides (C). Blockout channels available for internal blackout blinds.
- Flexible mounting options – top, back or side fixings.
- Small light gaps between fabric and side track for improved shading.

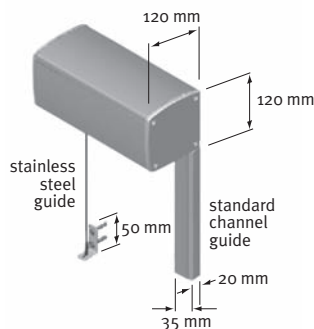

Dimensions

Type	Maximum Width (mm)	Minimum Width (mm)	Maximum Drop/Projection (mm)	Minimum Drop/Projection (mm)	Maximum Area (sqm)
System 2000					
- tape	2510	n/a	1800	n/a	4.34
- rope	4200	n/a	2400	n/a	10
- gear	3500	n/a	2000	n/a	7
- automatic	4200	710	2700	600	7.2
- motor	3600	n/a	2400	n/a	8.65
- internal tape winch	3600	n/a	2100	n/a	7.56
- Straight drop	4200	n/a	3000	n/a	12.6
Folding Arm Awnings					
- Ibiza	15000 [#]	†	3600*	1750	n/a
- Bedarra, Standard, Semi-Cassette	18000 [#]	†	3600*	1600	n/a
- Monaco	14000 [#]	†	3600*	1600	n/a
Shop Front					
	6000	n/a	3000	n/a	12.93
Robusta					
	20000 [#]	500	2400	n/a	n/a
External Sunscreen					
- tape	3000	500	2400	300	7.2
- crank	4000	500	4000	300	16
- motorised	4000	700	4000	300	16
# series connection		† depends on projection		*up to 15m width	

Specifications

Fabric	Composition	Weight gsm	Thickness mm	Openness Factor	Colourfastness (AS 2001.4.21)	Tensile Strength N	Tear Strength N	Flex Abrasion Resistance Cycles
Canvas	52/48 Poly/cotton mix	510	0.65	N/A	6-7	Warp - 2100 Weft - 1000	Warp - 87 Weft - 43	Warp - 1230 Weft - 1275
Solaire Acrylic	Fluorocarbon treated acrylic fabric	304	0.6	N/A	7	Warp - 1494 Weft - 815	Warp - 47 Weft - 34	Warp - 681 Weft - 921
ScreenShade	PVC coated polyester	590	0.65	12% average (dependent on colour)	6-7	Warp - 2954 Weft - 1548	Warp - 172 Weft - 91	Warp - 681 Weft - 921

Fire Retardant (AS 1530.3.1999)

Complies with the General Requirements of the Building Code of Australia for Fire Hazard properties of materials in buildings. Not suitable for use in parts of buildings with Special Requirements, i.e. fire isolated exits; public corridors leading to a fire isolated stairway, passageway or ramp; a patient care area of health care buildings; and in a public assembly building [e.g. theatre or hall] not protected with a sprinkler system.

	Canvas	Solaire Acrylic	ScreenShade
Ignitability Index (range 0-20)	16	16	0
Spread of Flame Index (range 0-10)	8	9	0
Heat Evolved Index (range 0-10)	5	4	0
Smoke Developed Index (range 0-10)	5	6	6

Fungal Resistance

Fabric Type	Leached	Heated
Canvas	0,0,0,0	0,0,0,0
Solaire Acrylic	1,1,1	1,1,1
ScreenShade	n/a	n/a

Energy Efficiency (ASTN E424-1971)

Fabric Type	SC	Ts	Tl	Rs	As	Tuv
Canvas (C15)	0.33	0	0	31	69	0
Solaire Acrylic (A900)	0.33	11	7	48	41	0
ScreenShade (Pearl White)	0.21	17	18	52	31	10

SC - Shading Coefficient
Ts - Heat Transmittance %
Tl - Light Transmittance %
Rs - Heat Reflectance %
As - Heat Absorbance %
Tuv - UV Transmittance

Luxaflex®
 Fabric Awnings and
 External Sunscreens

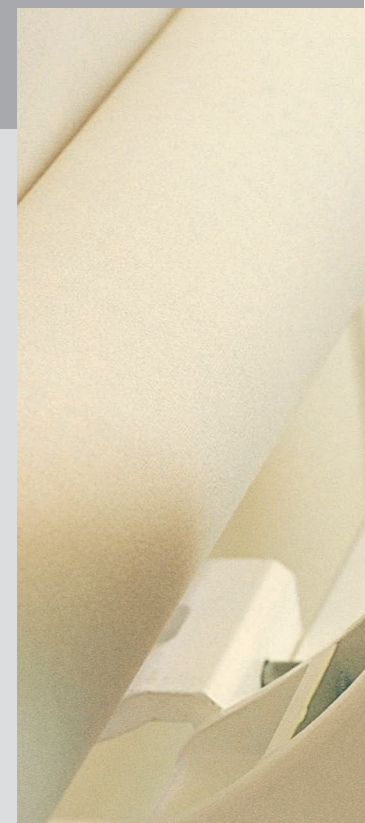

Specification Templates

Product Name	LUXAFLEX® SYSTEM 2000 Fabric Awnings
Awning Skin	The material used to provide the awning skin shall be Hunter Douglas Canvas/Solaire Acrylic/ScreenShade/..... fabric [other] and weighs approximately g/m ² .
Operating Method	The awnings shall be operated by Rope/Tape/Crank/Automatic Spring/Motorised.
Components	Aluminium components manufactured from extruded and die-cast methods. All plastic components are ultraviolet radiation stabilised. Steel components manufactured from Zincalume coated steel, painted using the HD COLOR-COTE® Thermosetting Polymer Paint System, coated to AS2728 Type 3.
Colour	The awning skin colour and pattern identified as fabric number and the headbox colour shall be
Fixing	Adjustable anchoring points shall be located above the window and fixed to timber studs/onto a masonry wall.

Product Name	LUXAFLEX® Folding Arm Awnings
Model	<ul style="list-style-type: none"> • Ibiza • Standard • Bedarra – Standard/ Variable Pitch • Semi-Cassette • Monaco Cassette (Only available from LUXAFLEX® Commercial)
Awning Skin	The material used to provide the awning skin shall be Solaire Acrylic fabric and weighs approximately 304 g/m ² .
Operating Method	The awnings shall be operated by Crank, Motorised or Motorised with a wind and sun sensor system.
Components	The retractable aluminium arms and other metal components are manufactured from corrosion resistant materials. Components for Monaco, Bedarra, Standard and Semi-Cassette are powder coated and Ibiza components are anodised to provide protection from harsh Australian environmental conditions. All plastic components are ultra violet radiation stabilised.
Colour	The awning skin colour and pattern identified as Solaire acrylic fabric number with colour co-ordinated trims.
Fixing	The awning shall be anchored to the roof truss or be mounted to a masonry wall.

Product Name	LUXAFLEX® Robusta Awnings
Awning Skin	The material used to provide the awning skin shall be Hunter Douglas Canvas/Solaire Acrylic/..... fabric [other] and weighs approximately g/m ² .
Operating Method	The awnings shall be Crank operated or Motorised.
Components	Aluminium components manufactured from extruded and die-cast methods. All plastic components are ultraviolet radiation stabilised.
Colour	The awning skin colour and pattern identified as fabric number with trims.
Fixing	Anchoring points at either end of the awning shall be located above/beside the window and fixed to timber studs or onto a masonry wall.

Product Name	LUXAFLEX® Shop Front Awning
Awning Skin	The material used to provide the awning skin shall be Hunter Douglas Canvas/Solaire Acrylic/..... fabric [other] and weighs approximately g/m ² .
Operating Method	The awnings shall be operated by rope.
Componentry	Aluminium components manufactured from extruded and die-cast methods. All plastic components are ultraviolet radiation stabilised.
Colour	The awning skin colour and pattern identified as fabric number and the headbox colour shall be
Fixing	The awning shall be fixed to the cantilevered shop front at either end of the awning. J-hooks shall be supplied to contain the awning in its lowered position.

Product Name	LUXAFLEX® Canopy Awning
Awning Skin	The material used to provide the awning skin shall be Hunter Douglas Canvas/Solaire Acrylic/ScreenShade/..... fabric [other] and weighs approximately g/m ² .
Operating Method	The awnings shall be fixed or retractable.
Components	Aluminium components manufactured from extruded and die-cast methods. All plastic components are ultraviolet radiation stabilised. Steel components manufactured from Zincalume coated steel.
Colour	The awning skin colour and pattern identified as fabric number
Fixing	Adjustable anchoring points shall be located above and/or beside the window and fixed to timber studs or onto a masonry wall.

Product Name	LUXAFLEX® External Sunscreen
Awning Skin	The material used to provide the awning skin shall be Hunter Douglas ScreenShade fabric, made from PVC coated polyester, weighing Approximately 590 g/m ² , with tensile strength 2,100N (warp) and 1,000N (weft) and openness factor 12%.
Hardware	The operating hardware shall be the Hunter Douglas EOS® External Sunscreen. The guiding shall be Aluminium channel guide/blockout guide/stainless steel cable.
Operating Method	The awnings shall be operated by Rope Winch/Gear/Motorised.
Components	Aluminium components manufactured from extruded and die-cast methods. All plastic components are ultraviolet radiation stabilised.
Colour	The awning skin colour and pattern identified as fabric number and the hardware colour shall be
Fixing	Adjustable anchoring points shall be located above the window and fixed to timber studs/onto a masonry wall.

Your LUXAFLEX® Commercial Contact is:

Hunter Douglas Limited

LUXAFLEX® Commercial
 338 Victoria Road, Rydalmere NSW 2116
Telephone: 1300 733 078
Facsimile: 1300 304 470
Email: luxaflex.commercial@hunterdouglas.com.au
www.luxaflex.com.au

